



INTERMEZZO™ 4.1t

Owner's Guide



CAUTION

RISK OF ELECTRIC SHOCK DO NOT OPEN

WARNING: SHOCK HAZARD, DO NOT OPEN.
AVIS: RISQUE DE CHOC ELECTRIQUE – NE PAS OUVRIR.
CUIDADO: PELIGRO DE CHOQUE ELÉCTRICO – NO ABRIR.

CAUTION: TO REDUCE THE RISK OF ELECTRIC SHOCK
DO NOT REMOVE COVER (OR BACK)
NO USER SERVICEABLE PARTS INSIDE
REFER SERVICING TO QUALIFIED PERSONNEL

THIS INFINITY PRODUCT IS DESIGNED FOR 120-VOLT USE ONLY! FOR DETAILED SAFETY PRECAUTIONS, PLEASE SEE FOLLOWING PAGE IN THIS OWNER'S MANUAL FOR "IMPORTANT SAFETY INSTRUCTIONS."

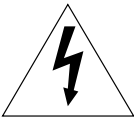

The lightning flash with arrowhead symbol, within an equilateral triangle, is intended to alert the user to the presence of uninsulated "dangerous voltage" within the product's enclosure that may be of sufficient magnitude to constitute a risk of electric shock to persons.



The exclamation point within an equilateral triangle is intended to alert the user to the presence of important operating and maintenance (servicing) instructions in the literature accompanying the product.

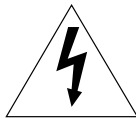

L'éclair avec le symbole de la flèche, placé dans les limites d'un triangle équilatéral est prévu pour avertir l'utilisateur de la présence de "tension dangereuse" non isolée dans l'enceinte du produit qui pourrait être d'une importance suffisante pour présenter un risque d'électrocution aux personnes.



Le point d'exclamation dans un triangle équilatéral est prévu pour avertir l'utilisateur de la présence d'instructions importantes pour les opérations et l'entretien (service) dans les manuels fournis avec l'appareil.

ATTENTION: POUR EVITER LES CHOCS ELECTRIQUES, INTRODUIRE LA LAME LA PLUS LARGE DE LA FICHE DANS LA BORNE CORRESPONDANTE DE LA PRISE ET POUSSER JUSQU'AU FOND.

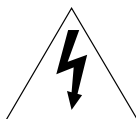

Este destello luminoso con un símbolo de punta de flecha dentro de un triángulo equilátero tiene el objetivo de alertar al usuario sobre la presencia de "voltaje peligroso" no aislado dentro de la caja del producto que puede ser de magnitud lo suficientemente grande para constituir un riesgo de choque eléctrico para las personas.



Este punto de exclamación dentro de un triángulo equilátero tiene el objetivo de alertar al usuario sobre la existencia de instrucciones operativas y de mantenimiento (servicio) importantes en la literatura que acompaña el aparato.

CUIDADO: PARA REDUCIR EL RIESGO DE CHOQUE ELÉCTRICO, NO RETIRE LA CUBIERTA (O RESPALDO). DENTRO NO HAY PEIZAS A LAS QUE EL USUARIO PUEDE DAR SERVICIO. REMITA EL SERVICIO AL PERSONAL DE SERVICIO CALIFICADO.

IMPORTANT SAFETY PRECAUTIONS

Read First!

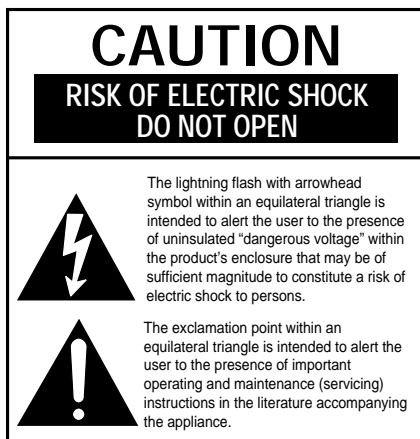

- 1. Read Instructions.** All the safety and operating instructions should be read before the product is operated.
- 2. Retain Instructions.** The safety and operating instructions should be retained for future reference.
- 3. Heed Warnings.** All warnings on the product and in the operating instructions should be adhered to.
- 4. Follow Instructions.** All operating and use instructions should be followed.
- 5. Cleaning.** Unplug this product from the wall outlet before cleaning. Do not use liquid cleaners or aerosol cleaners. Use a damp cloth for cleaning.
- 6. Attachments.** Do not use attachments not recommended by the product manufacturer, as they may cause hazards.
- 7. Water and Moisture.** To reduce the risk of fire or electric shock, do not use this product outdoors or near water—for example, near a bathtub, wash bowl, kitchen sink or laundry tub; in a wet basement; near a swimming pool; or the like.
- 8. Accessories.** Do not place this product on an unstable cart, stand, tripod, bracket or table. The product may fall, causing serious injury to a child or adult, and serious damage to the product. Use only with a cart, stand, tripod, bracket or table recommended by the manufacturer, or sold with the product. Any mounting of the product should follow the manufacturer's instructions, and should use a mounting accessory recommended by the manufacturer.
- 9. A Product and Cart Combination Should Be Moved with Care.** Quick stops, excessive force and uneven surfaces may cause the product and cart combination to overturn.



- 10. Ventilation.** Slots and openings in the cabinet are provided for ventilation and to ensure reliable operation of the product and to protect it from overheating, and these openings must not be blocked or covered. The openings should never be blocked by placing the product on a bed, sofa, rug or other similar surface. This product should not be placed in a built-in installation, such as a bookcase or rack, unless proper ventilation is provided or the manufacturer's instructions have been adhered to.

11. Power Sources. This product should be operated only from the type of power source indicated on the marking label. If you are not sure of the type of power supply to your home, consult your product dealer or local power company. For products intended to operate from battery power, or other sources, refer to the operating instructions.

12. Grounding or Polarization. This product may be equipped with a polarized alternating-current-line plug (a plug having one blade wider than the other). This plug will fit into the power outlet only one way. This is a safety feature. If you are unable to insert the plug fully into the outlet, try reversing the plug. If the plug should still fail to fit, contact your electrician to replace your obsolete outlet. Do not defeat the safety purpose of the polarized plug.

13. Power-Cord Protection. Power-supply cords should be routed so that they are not likely to be walked on or pinched by items placed upon or against them, paying particular attention to cords at plugs, convenience receptacles, and the point where they exit from the product.

14. Nonuse Periods. The power cord of the product should be unplugged from the outlet when left unused for long periods of time.

15. Outdoor Antenna Grounding. If an outside antenna or cable system is connected to the product, be sure the antenna or cable system is grounded so as to provide some protection against voltage surges and built-up static charges. Article 810 of the National Electrical Code, ANSI/NFPA 70, provides information with regard to proper grounding of the mast and supporting structure, grounding of the lead-in wire to an antenna discharge unit, size of grounding conductors, location of antenna-discharge unit, connection to grounding electrodes, and requirements for the grounding electrode. See Figure A.

16. Lightning. For added protection for this product during a lightning storm, or when it is left unattended and unused for long periods of time, unplug it from the wall outlet and disconnect the antenna or cable system. This will prevent damage to the product due to lightning and power-line surges.

17. Power Lines. An outside antenna system should not be located in the vicinity of overhead power lines or other electric light or power circuits, or where it can fall into such power lines or circuits. When installing an outside antenna system, extreme care should be taken to keep from touching such power lines or circuits, as contact with them might be fatal.

18. Overloading. Do not overload wall outlets, extension cords, or integral convenience receptacles, as this can result in a risk of fire or electric shock.

19. Object and Liquid Entry. Never push objects of any kind into this product through openings, as they may touch dangerous voltage points or short-out parts that could result in a fire or electric shock. Never spill liquid of any kind on the product.

20. Servicing. Do not attempt to service this product yourself, as opening or removing covers may expose you to dangerous voltage or other hazards. Refer all servicing to qualified service personnel.

21. Damage Requiring Service. Unplug this product from the wall outlet and refer servicing to qualified service personnel under the following conditions:

- The power-supply cord or the plug has been damaged; or
- Objects have fallen onto, or liquid has been spilled into, the product; or
- The product has been exposed to rain or water; or
- The product does not operate normally when following the operating instructions. Adjust only those controls that are covered by the operating instructions, as an improper adjustment of other controls may result in damage and will often require extensive work by a qualified technician to restore the product to its normal operation; or
- The product has been dropped or damaged in any way; or
- The product exhibits a distinct change in performance; this indicates a need for service.

22. Replacement Parts. When replacement parts are required, be sure the service technician has used replacement parts specified by the manufacturer or that have the same characteristics as the original part. Unauthorized substitutions may result in fire, electric shock or other hazards.

23. Safety Check. Upon completion of any service or repairs to this product, ask the service technician to perform safety checks to determine that the product is in proper operating condition.

24. Wall or Ceiling Mounting. The product should be mounted to a wall or ceiling only as recommended by the manufacturer.

25. Heat. The product should be situated away from heat sources such as radiators, heat registers, stoves or other products (including amplifiers) that produce heat.

Figure A.
Example of Antenna Grounding as per
National Electrical Code ANSI/NFPA 70

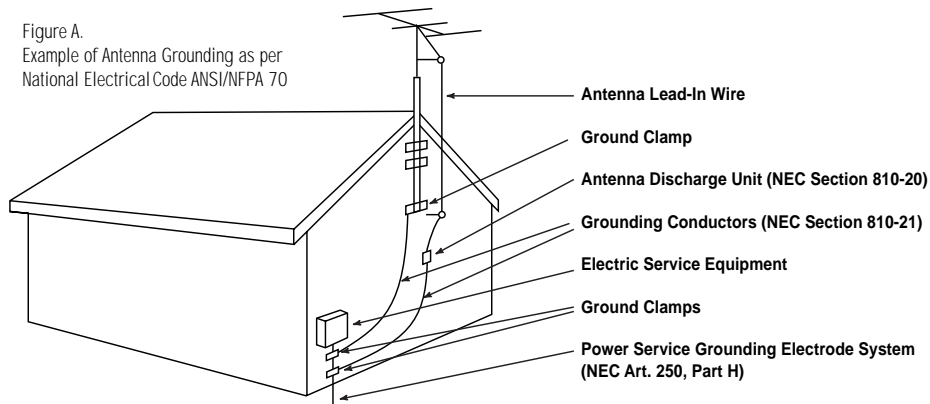

INTERMEZZO 4.1t OWNER'S GUIDE

Table of Contents

ii	Caution
iii	Important Safety Precautions
1	Technology
1	Ceramic Metal Matrix Diaphragms™ (C.M.M.D.)
1	Transducers
1	Room-Friendly Acoustical Design
2	Amplifier
2	Completing the Experience
2	Unpacking the Product/Included Accessories
3	Placement
4	Controls and Connections
5	Connection Methods 1–4
8	Room Adaptive Bass Optimization System™ (R.A.B.O.S.)
9	Contents of the R.A.B.O.S. Test CD
9	R.A.B.O.S. Sound-Level Meter (RSLM)
14	What You Measure, What To Do
17	Adjusting the R.A.B.O.S. Equalizer
18	Final System Balance
19	Maintenance and Service
20	Specifications
21	R.A.B.O.S. Measurement Templates
23	Notes

Infinity Intermezzo 4.1t

This loudspeaker system represents a refinement of the principles that have guided Infinity's loudspeaker designs for more than 30 years. Loudspeaker development is generally an evolutionary process. New models usually perform slightly better than the ones they replace. Over time, the subtle improvements add up and, when the latest model is compared to a loudspeaker that is ten or twelve years old, the disparity is unmistakable.

Every once in a while, a loudspeaker is developed that transcends this pattern – its performance so remarkable, its design so stunning, its technology so advanced, it can truly be described as revolutionary. The new Infinity Intermezzo 4.1t loudspeaker system is an elegant case in point.

The Intermezzo 4.1t system is a 4-way loudspeaker with its mid-bass, midrange and high-frequency-driver array mounted atop a 12", 850-watt powered subwoofer. With its proprietary Ceramic Metal Matrix Diaphragms™, powerful BASH® amplifiers and sophisticated, yet refined, dividing networks, the Intermezzo 4.1t will breathe life into any musical or cinematic performance and touch the soul of the listener. The Intermezzo 4.1t is the consummation of Infinity's quest to apply "science in the service of art."

TECHNOLOGY

The Intermezzo 4.1t system incorporates several innovative technologies that, when implemented by exceptional engineering talent after hours upon hours of subjective listening evaluations, result in a loudspeaker that realistically and accurately reproduces the signal source with minimal distortion and coloration.

Ceramic Metal Matrix Diaphragms™ (C.M.M.D.™)

For decades, loudspeaker engineers have known that the ideal transducer should be stiff, yet light, and have high internal damping (damping is a material's ability to absorb energy). Infinity's C.M.M.D. transducer is a significant advance in transducer technology. Ceramic, a class of material new to loudspeakers, offers better performance than that of other materials. Ceramic is stiffer than metals and lighter than plastics and typical composite materials; it also offers improved damping. These ceramic-based transducers take us a giant step closer to the ever-elusive "ideal transducer."

In tweeters, C.M.M.D. technology offers stiffness and damping superior to that of traditional metals and soft-dome materials. In woofer and midrange applications, it offers accurate piston operation over the entire frequency range of the driver, completely eliminating coloration due to cone breakup and dramatically reducing distortion. And when ceramic-metal-matrix transducers are exposed to moisture, sunlight or extreme temperatures, their performance does not deteriorate.

Transducers

In addition to ceramic diaphragms, all the transducers incorporate magnetic shielding and rigid cast-frames that, through our FEA computer modeling and scanning-laser-vibrometer measurements, have been optimized to reduce resonances. This ensures minimal distortion and incomparable performance. The 12" low-frequency transducer is the embodiment of uncompromised driver design. The ceramic-metal-matrix cone is attached to a rigid cast-aluminum frame, through a compression-molded, butyl-rubber surround. The motor assembly incorporates a vented polepiece for maximum heat dissipation with negligible air turbulence. The frame itself is also vented to further improve heat dissipation. The motor structure uses a 3" edge-wound, copper voice coil for high power handling and minimal power compression.

To maximize system performance, the flat-spider assembly and the cone are mounted to different points on the fiberglass former, increasing reliability and reducing distortion, especially at high output levels. An extra-thick top plate and dual-magnet structure are utilized to allow for huge peak-to-peak driver excursions, with significantly lower distortion and a more linear frequency response than is true of typical drivers.

When installed in its heavily braced and reinforced elliptical enclosure and coupled with a powerful 850-watt amplifier and Infinity's proprietary Room Adaptive Bass Optimization System™ (R.A.B.O.S.), this 12" low-frequency transducer allows the Intermezzo 4.1t system to deliver bass that will cleanly and naturally reproduce the lowest notes of a pipe organ or the loudest explosions from last summer's hottest action films.

Room-Friendly Acoustical Design

Driver quality is not the only requirement for exceptional performance. Infinity's engineers understand that the room in which the loudspeaker is placed can greatly affect its performance. To ensure that the Intermezzo 4.1t will sound exceptional in even the most unexceptional listening environment, Infinity has developed two ways to solve most room-generated problems. The first is its proprietary Room Adaptive Bass Optimization System. With a single band of parametric equalization, the Intermezzo 4.1t can be adjusted to tame any problematic room bass resonances below 80Hz.

There is a completely different set of room-related problems that has to do with loudspeaker directivity and that can affect the reproduction of mid and high frequencies. One characteristic of forward-facing loudspeakers is that the sound output lessens as one moves away from the principal axis. This happens both horizontally and vertically and it means that radiated sounds that are reflected from the floor, ceiling and side walls will be lower in amplitude than direct, forward sound. This is usually a good thing. But, if the dispersion characteristics of the loudspeaker are different at various frequencies, the sound quality of the reflected sounds will be very different both from each other and

from the first (i.e., direct) sound. The ears don't ignore these differences; they perceive them as coloration, or as sound quality that's been degraded. The Intermezzo 4.1t has been carefully designed to maintain a directional pattern that is similar at every important angle, on and off axis. The positive result is that both direct and reflected sounds arriving at the listeners' ears have similar timbral signatures.

Amplifier

BASH is an amplifier-power-supply technology that increases efficiency by reducing power dissipation in the output section. The BASH topology uses a high-efficiency, fast-response, switch-mode power supply that provides the main voltage rails for a linear Class-AB amplifier. By varying the output of the power supply with the audio signal being amplified, a constant voltage drop across the output transistors of the linear amplifier can be maintained. This means that the power dissipation in the output transistors is greatly reduced.

The result is an extremely efficient audio amplifier that does not compromise audio performance.

Completing the Experience

The technology and performance that make the Infinity Intermezzo 4.1t loudspeakers ideal for music listening also make them the perfect digital multichannel loudspeaker system. To complete a home-theater system, Infinity has designed, to the same precise standards as the Intermezzo 4.1t, a matching 3-way center-channel loudspeaker, the Intermezzo 3.5c. In addition, Intermezzo 2.6 bookshelf loudspeakers are available for use as full-range surround channels.

We hope you enjoyed this brief introduction to the technology of the Intermezzo 4.1t loudspeaker system. If you would like to further explore the technology and design of the Intermezzo loudspeaker system, please ask your Infinity dealer for the C.M.M.D. and R.A.B.O.S. White Papers. The White Papers can also be downloaded from Infinity's Web site at www.infinitysystems.com.

Unpacking the Product

Finish unpacking the speakers and check the contents. If you suspect damage from transit, report it immediately to your dealer and/or delivery service. Keep the shipping carton and packing materials for future use.

Included Accessories . . .

R.A.B.O.S. Kit (1) (Included with Left Subwoofer Only)

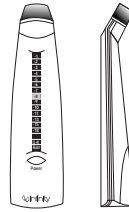

Sound-Level Meter



R.A.B.O.S. Test CD

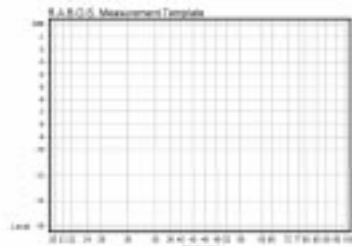

Graph Templates

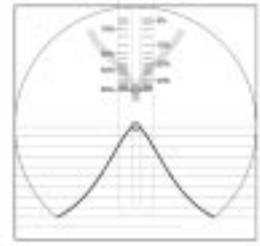

Bandwidth Selector

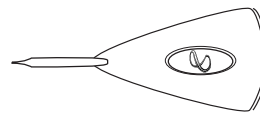

Adjustment Key

Grilles (2)

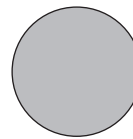

Decorative Side Panels (2)



AC Cord

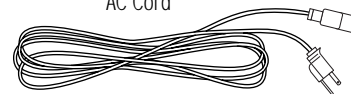

PLACEMENT

The Infinity Intermezzo 4.1t is designed to offer excellent performance in any listening room or home-theater system. However, the following placement guidelines and suggestions will start you on your way to achieving optimum performance. Remember, these are guidelines. We suggest you experiment with positioning the loudspeakers to determine their ideal placement in your particular listening room.

2-Channel or Front Left and Right in a Home-Theater System

Generally, the system should be placed at least three feet away from the side walls. In 2-channel applications, the two speakers should be equidistant from your primary listening position. We recommend that the angle formed between the speakers and the listening area be between 45° and 60° . For example, if the speakers are 8' apart, your listening position should be 8' to 12' from each speaker. See Figure 1. With wider speaker separations, it may be advantageous to slightly angle the speakers, aiming them toward the listening area.

When used as part of a home-theater system, you may find that you achieve excellent performance with the left and right speakers spread apart even further. Feel free to experiment with the placement of the speakers to achieve the best possible sound in your listening room.

Normally, it is recommended that the driver of each subwoofer face toward the outside, and this is how the subs are packaged. In some rooms, however, the system may perform better with the woofers facing the inside. Feel free to experiment.

Surround Channels in a Home-Theater System

When used as part of a Dolby® Pro Logic®, THX®, or discrete 5.1-channel home-theater system, the surround speakers should be placed at the sides of, and directed toward, the main listening area. See Figure 2. If there are several rows of seating, place the speakers, as described above, perpendicular to, or slightly behind, the last row of seating.

When used as part of a 7-channel music or home-theater system, place the side speakers at the sides of and directed toward the main listening area. If there are several rows of seating, place the speakers, as described above, perpendicular to the middle row of seating. The rear speakers should be placed on the rear wall facing the front of the room. Each rear speaker should be about 1/3 of the way into the room, but never to the outside of the listening area. See Figure 3.

As mentioned earlier, Intermezzo 4.1t offers several ways to fine-tune the system for optimum performance in any listening room. These techniques, as well as Infinity's exclusive R.A.B.O.S. system, will be discussed in detail later in this manual.

FIGURE 1

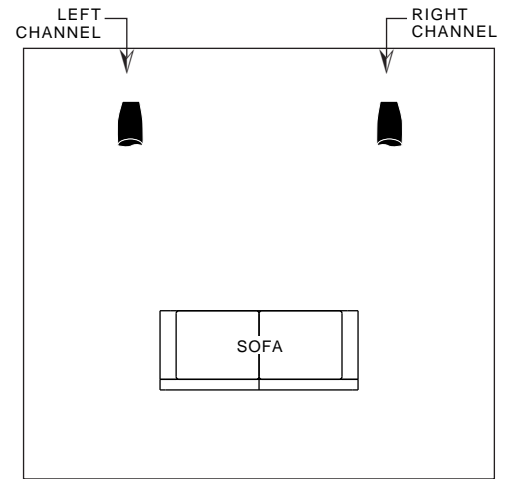

FIGURE 2

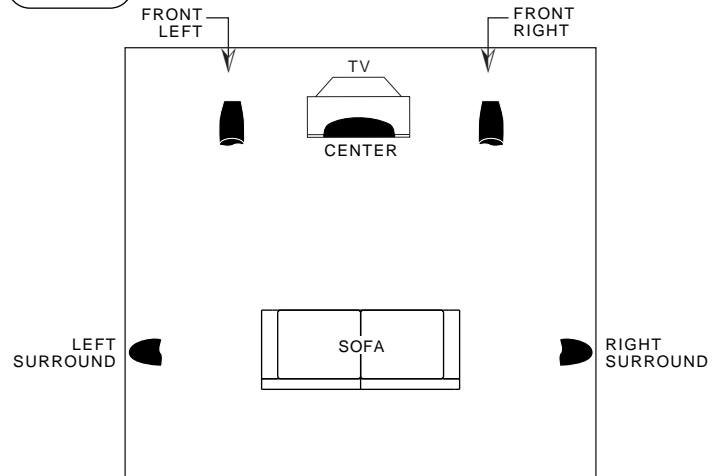
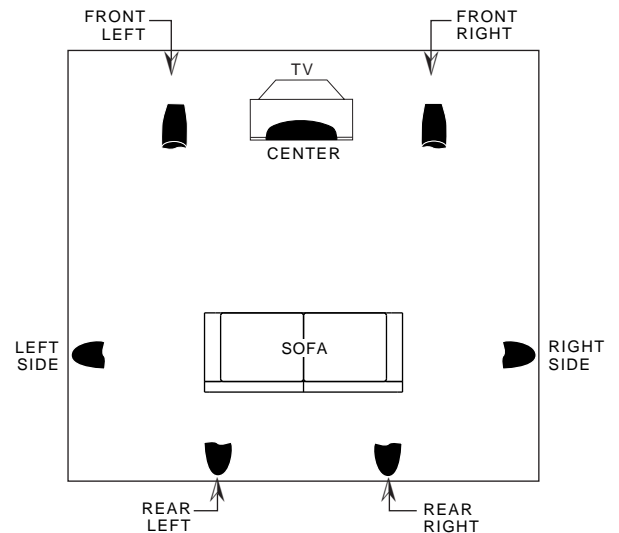
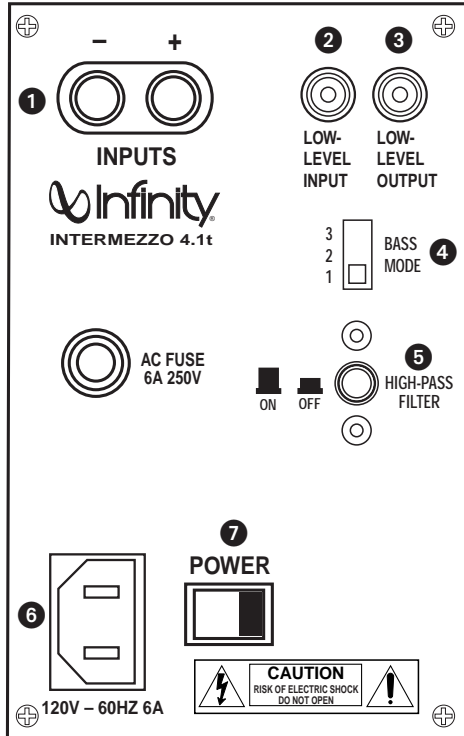

FIGURE 3



CONTROLS AND CONNECTIONS

Rear Panel



- ❶ Speaker-Level Input
- ❷ Low-Level-Input Connector
- ❸ Low-Level-Output Connector
- ❹ Bass-Mode Switch
- ❺ High-Pass Filter Switch
- ❻ AC-Cord Input
- ❼ Power Switch

Front Panel

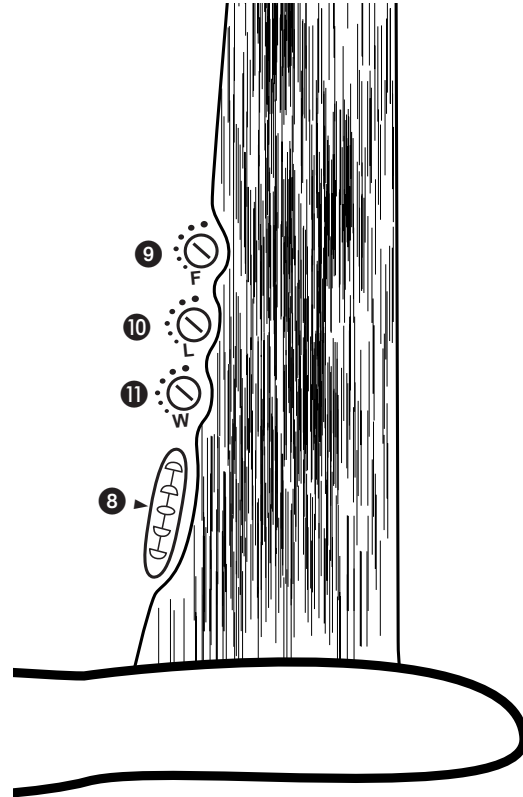

- ❽ Subwoofer-Level Control
- R.A.B.O.S. Controls
- ❹ Center-Frequency Adjustment
 - ❺ R.A.B.O.S. Level
 - ❻ Bandwidth Adjustment

The Infinity Intermezzo 4.1t offers unprecedented flexibility for connecting the system to any type of audio or home-theater system. Consult the table at right to determine which system description most closely matches your own, then follow the hook-up method corresponding to that system.

If none of these system configurations seem to match yours, consult your dealer or Infinity customer service for direction on how best to hook up your system.

For Methods 2, 3a, 3b and 4, make sure all bass-management features are properly set. The Audio channels should all be set to "Small" or "High-Pass" and the subwoofer set to "On."

System Type	Connection Methods
2-Channel receiver or integrated amplifier that has no subwoofer output or Pre-out/Main-In connectors	1
2-Channel receiver or integrated amplifier with preamp output and input connectors	2
2-Channel system with separate preamplifier and power amplifier	2
Dolby Pro Logic with THX, Dolby Digital, or DTS® receiver with a filtered subwoofer (or LFE) output connector	3a
Dolby Digital or DTS processor with separate power amplifiers or multichannel amplifier	3b
Non-THX certified Dolby Pro Logic receiver with full-range subwoofer outputs	4

Method 1

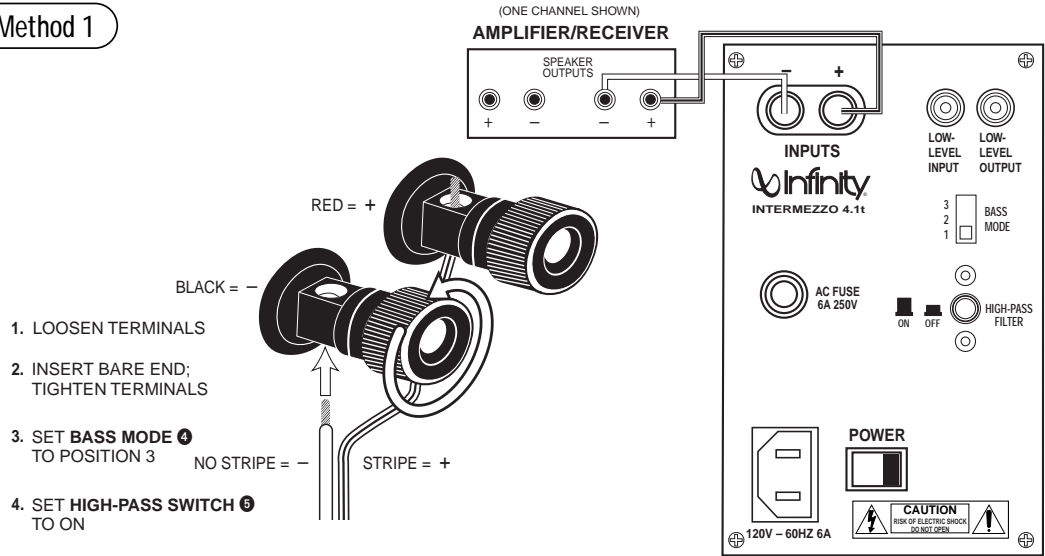

1. LOOSEN TERMINALS
2. INSERT BARE END; TIGHTEN TERMINALS
3. SET **BASS MODE 4** TO POSITION 3
4. SET **HIGH-PASS SWITCH 5** TO ON

Method 2

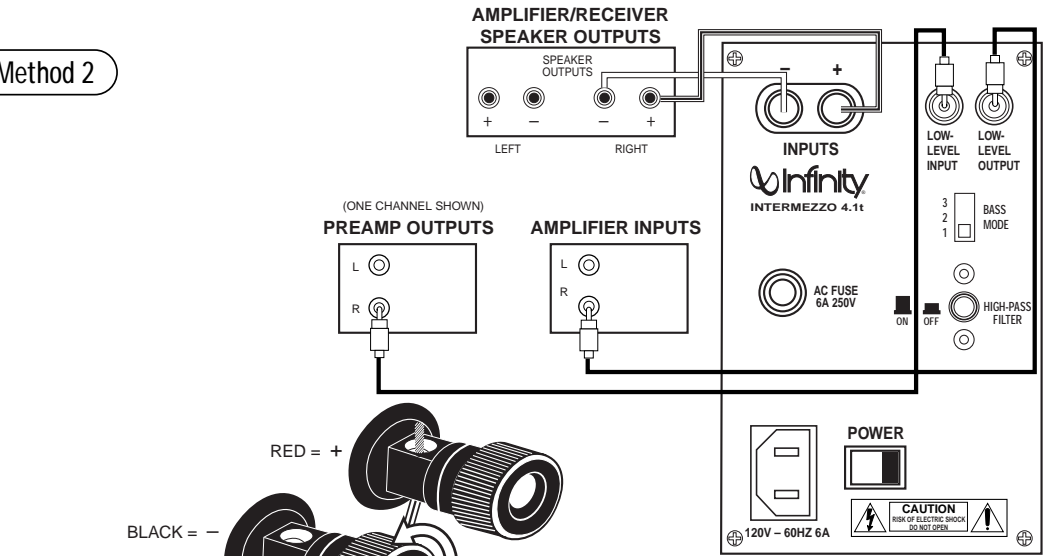

1. LOOSEN TERMINALS
2. INSERT BARE END; TIGHTEN TERMINALS
3. SET **BASS MODE 4** TO POSITION 2
4. SET **HIGH-PASS SWITCH 5** TO OFF

Method 3a

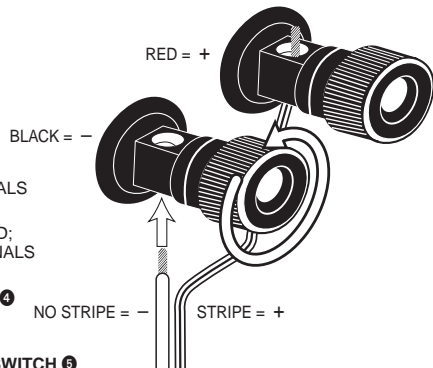
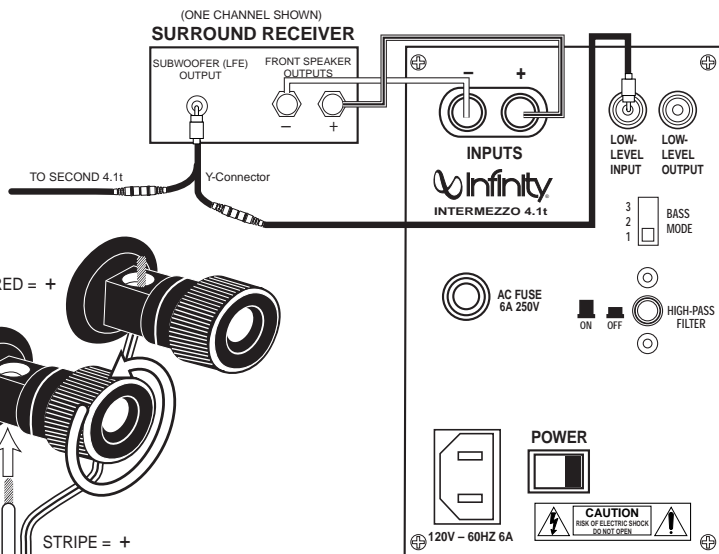

1. LOOSEN TERMINALS
2. INSERT BARE END; TIGHTEN TERMINALS
3. SET **BASS MODE** 4 TO POSITION 1
4. SET **HIGH-PASS SWITCH** 5 TO OFF

Method 3b

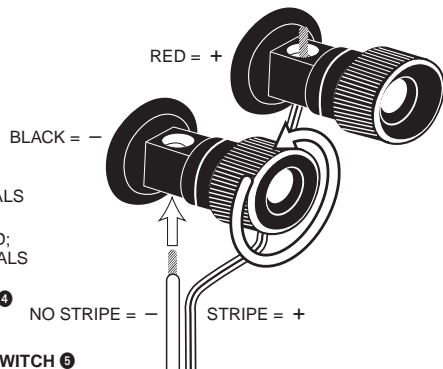
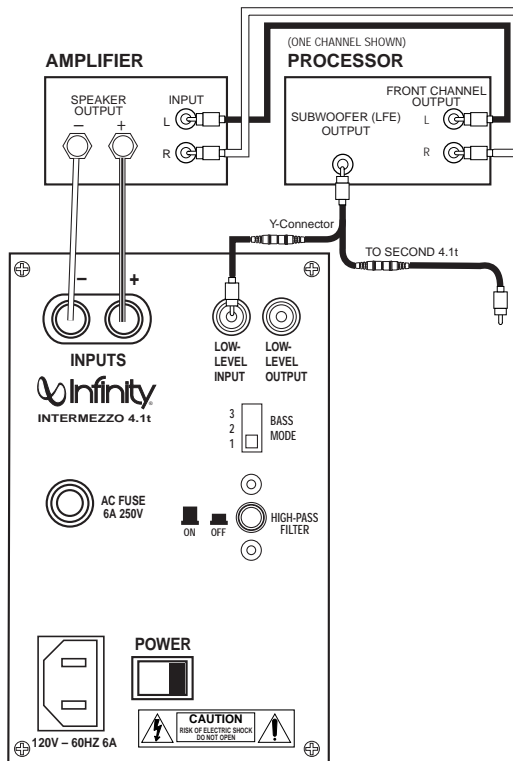

1. LOOSEN TERMINALS
2. INSERT BARE END; TIGHTEN TERMINALS
3. SET **BASS MODE** 4 TO POSITION 1
4. SET **HIGH-PASS SWITCH** 5 TO OFF

Method 4

1. LOOSEN TERMINAL

2. INSERT BARE END; TIGHTEN TERMINAL

3. SET **BASS MODE** ④ TO POSITION 2

4. SET **HIGH-PASS SWITCH** ⑤ TO ON

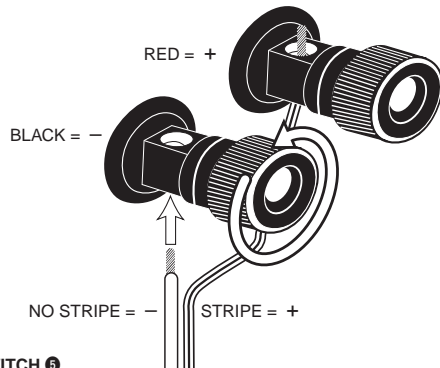

(ONE CHANNEL SHOWN)

RECEIVER

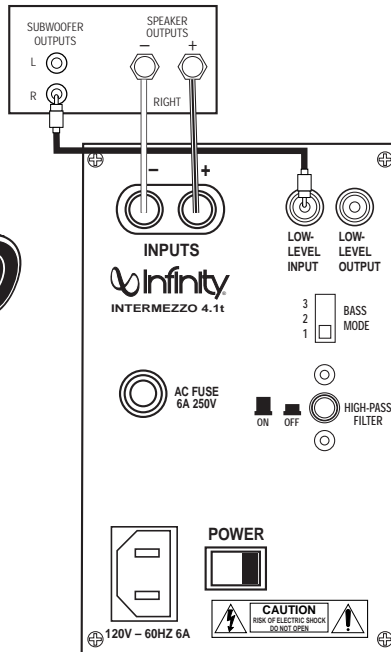

Final Positioning

After correctly connecting the Intermezzo 4.1t and verifying that both the subwoofer and main section portions are playing, it is time to optimize the system for your particular listening room.

Earlier, you placed the loudspeakers in their general location. Finding the exact location for optimum performance sometimes only involves moving the speakers up to a few inches in any direction. We urge you, therefore, to experiment with placement until your speakers deliver their full potential. When the speakers are moved inward (toward each other) there is generally better focus of instruments and vocalists; however, moving the speakers too close together can reduce the spaciousness of the stage effect and you may need to experiment with the trade-off between focus and imaging. If your listening room is larger than average and your listening position is relatively far from the speakers, wider placement of the speakers may be required.

ROOM ADAPTIVE BASS OPTIMIZATION SYSTEM

Infinity R.A.B.O.S. is a simple-to-use, yet sophisticated, low-frequency calibration system. It is designed to work in conjunction with Infinity Intermezzo self-amplified subwoofers. Each Intermezzo subwoofer contains a parametric equalizer that you will adjust as indicated by the R.A.B.O.S. test results. Following these instructions, you will optimize the Intermezzo subwoofers' response characteristics to complement their environment. This will dramatically improve the sound of your system. The optimization process takes less than 30 minutes.

The R.A.B.O.S. Kit Includes the Following Components:

- Specialized Sound-Level Meter
- Test CD
- Instructions
- Measurement Templates
- Width Selector
- Adjustment "Key"

What R.A.B.O.S. Does

The Test CD provides specially designed signals you will use while performing measurements. The sound-level meter provided is used to "acquire" the information needed for adjustments. You will create a response plot on the Measurement Template. Using the Width Selector, you will then determine the appropriate equalizer settings. The "Key" is used to adjust the parametric equalizer built into each Intermezzo subwoofer. After adjustment, the test sequence is repeated to confirm your settings.

The R.A.B.O.S. Goal

It is a fact of audio that what we hear at low frequencies is determined as much or more by the listening room than by the loudspeaker itself. Placement of the loudspeakers and listeners and the acoustical characteristics of the room surfaces are all important determinants of bass quantity and quality. In most practical situations, there is little that can be done about this, except for patient trial-and-error repositioning of the loudspeakers and listeners. Usually, the practical constraints of a living space and the impracticality of massive acoustical treatment mean that equalization is the only practical solution.

Professional sound engineers routinely employ sophisticated measurement systems and equalizers to optimize speakers to the installation. This has never been practical for the home audiophile. This is why R.A.B.O.S. was created. R.A.B.O.S. enables you to identify the dominant low-frequency response characteristic of your room. Once you know the problem, R.A.B.O.S. provides the tools needed to optimize the low-frequency characteristics of the speakers to the room they are in, exactly as the professional sound engineers do it.

Performing R.A.B.O.S. Tests

These instructions assume you have already installed your Intermezzo speakers according to the information provided in the Owner's Guide. It is also assumed that all equipment in your entertainment system is interconnected properly and is in good operating condition.

Preparations

Before beginning R.A.B.O.S. tests, please check the following:

- Make sure all three R.A.B.O.S. controls on the Intermezzo 4.1t are turned fully clockwise.
- Make sure the loudness contour (if any) on your receiver/processor/preamp is turned off.
- Set the tone controls (Bass and Treble) to their center or flat positions.
- Bypass all surround and effects features of your receiver/processor/preamp or set to Stereo Bypass.
- If you are using a multichannel surround processor or receiver, make sure all bass-management features are properly set. The Audio channels should all be set to "Small" or "High-Pass" and the subwoofer set to "On."

You must have a CD player in the system. A CD player remote control is quite convenient but not essential.

For best results, it is recommended that all major furnishings are in place and that all doors and windows in the listening area are in their normal positions. That is, if you normally listen to music with all doors closed, then this is how they should be during this procedure.

Try to minimize ambient noise while running tests. Turn off all major appliances and any air conditioning or furnace fans. These can create significant subsonic noise that may be barely perceptible but which can wreak havoc on low-frequency measurements.

Critical information is highlighted with this mark: ⓘ

Helpful hints are marked with this symbol: ⚙️➡️

Contents of the R.A.B.O.S. Test CD

Track	Title	Track	Title
1	Welcome	32	Quick Retest 80Hz
2	Set System Test Level	33	Quick Retest 77Hz
3	Set Subwoofer Test Level	34	Quick Retest 72Hz
4	100Hz Test	35	Quick Retest 66Hz
5	95Hz Test	36	Quick Retest 63Hz
6	90Hz Test	37	Quick Retest 56Hz
7	85Hz Test	38	Quick Retest 52Hz
8	80Hz Test	39	Quick Retest 49Hz
9	77Hz Test	40	Quick Retest 46Hz
10	72Hz Test	41	Quick Retest 43Hz
11	66Hz Test	42	Quick Retest 40Hz
12	63Hz Test	43	Quick Retest 38Hz
13	56Hz Test	44	Quick Retest 35Hz
14	52Hz Test	45	Quick Retest 30Hz
15	49Hz Test	46	Quick Retest 26Hz
16	46Hz Test	47	Quick Retest 24Hz
17	43Hz Test	48	Quick Retest 22Hz
18	40Hz Test	49	Quick Retest 21Hz
19	38Hz Test	50	Quick Retest 20Hz
20	35Hz Test	51	Final System Level Adjustment
21	30Hz Test	52	Final Subwoofer Level Adjustment
22	26Hz Test	53	Wide Band Pink Noise, Left
23	24Hz Test	54	Wide Band Pink Noise, L+R
24	22Hz Test	55	Wide Band Pink Noise, Right
25	21Hz Test	56	Wide Band Pink Noise, L-R
26	20Hz Test	57	Wide Band Pink Noise, Uncorrelated
27	Intro to Quick Retest	58	1 to 4kHz Pink Noise, Left
28	Quick Retest 100Hz	59	1 to 4kHz Pink Noise, L+R
29	Quick Retest 95Hz	60	1 to 4kHz Pink Noise, Right
30	Quick Retest 90Hz	61	1 to 4kHz Pink Noise, Left-R
31	Quick Retest 85Hz	62	1 to 4kHz Pink Noise, Uncorrelated

Tracks 53–62 of the R.A.B.O.S. Test CD are test tones that can be used for general diagnostics of your system. They are not used for R.A.B.O.S. settings.

THE R.A.B.O.S. SOUND-LEVEL METER (RSLM)

The RSLM is a battery-operated, handheld, acoustic measurement device specifically designed for Infinity R.A.B.O.S. On the face of the instrument is a light-emitting diode (LED) bar graph that indicates relative sound level. There are also indicators for power-on, out-of-range signals and a low battery.

FIGURE 4

R.A.B.O.S. Sound-Level Meter

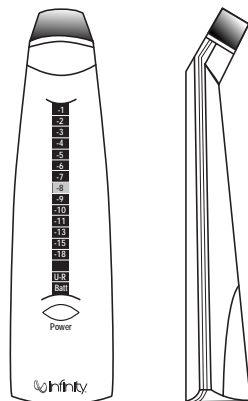

Power is switched on or off by pressing the button directly below the bar-graph window. When the unit is on, one or more LEDs will always be illuminated. The function of the LEDs is described in the following section.

FIGURE 5

RSLM bar-graph indications

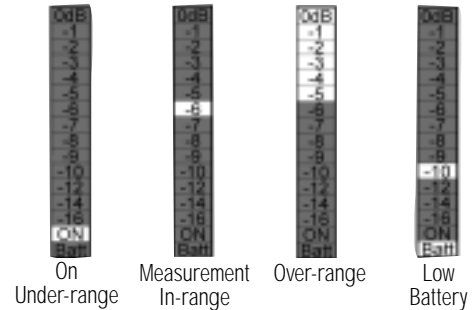

- **Power-On/Low Signal:** This is indicated by the illumination of any LED on the bar graph. If the sound level in the room is below the measurement range of the instrument, a green LED near the bottom of the bar graph will be illuminated.
 - **Normal Measurements:** When the sound level is within the range of the RSLM, the green LED will be off and one of the red LEDs in the bar graph will be illuminated, indicating the relative sound level, in decibels (dB).
 - **Over-Range:** If the sound level exceeds the range of the meter, 0dB through -5 will all light simultaneously.
 - **Low Battery:** When the battery voltage is too low for accurate measurements, an LED at the bottom of the bar graph will be illuminated. Replace the battery.
- ⓘ Do not attempt measurements when this light is on.

RSLM Placement

Determine where in the room you are most likely to sit when listening to music or watching a movie. This is where you will want to hold the RSLM during measurements. The RSLM should be oriented so it can be easily read and held at your seated ear level during tests.

- ⓘ You must use this same position for all tests.

🔑 The RSLM can be mounted on a standard camera tripod. This will ensure the best results.

Initial System-Level Setting

The following steps will set the playback level of the system to the correct level for all tests that follow.

① Turn the system volume to minimum.

Cue the R.A.B.O.S. Test CD to Track 2 and press **Pause II**. This track will produce band-limited pink noise in both the left and right channels.

Press **Play** ▶ With the RSLM positioned as described above, increase the system volume until the RSLM display indicates -10dB. See Figure 6.

FIGURE 6

RSLM indicating the correct system level to begin tests (-10dB)

When you have completed this adjustment, press **Pause II**.

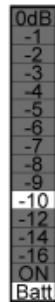

Setting the Subwoofer Test Level

⌚ Each of the following test tracks is about one minute long. This is normally much longer than required. Press **Pause II** or advance to the next test as soon as you are ready.

This step will set the subwoofer levels for measurement purposes. The objective is to scale the subwoofers' output to make full use of the RSLM indicator range. Scaling is optimum when a 0dB reading is observed on the highest peak without triggering the over-range indication. Later, you will rebalance the subwoofers to the main speakers.

① The Intermezzo subwoofers should be shipped with the three R.A.B.O.S. controls, ⑨, ⑩ & ⑪, set to fully clockwise positions, and all measurements should be conducted with their level controls in this position. Confirm this setting before you begin this test. The level control ⑧ should be set to the mid position (5).

Cue Track 3 and **Pause II**. Track 3 continuously steps through all subwoofer test tones for approximately 1 minute. Each tone will play just long enough for the RSLM to give a stable reading.

⌚ To get accurate measurements, it is necessary to play the woofers quite loud. The 0dB indication is about 94dB. At this level, frequencies below 100Hz can cause doors, windows, furnishings and other objects in the room to vibrate. This frequently results in clearly audible buzzes and/or rattles that come and go as each test tone plays. Strong buzzes not only sound bad, they can cause measurement errors. If you hear a buzz or rattle during this test, it is highly recommended that you

locate the source and eliminate its effects. This is actually a valuable room-diagnostic tool.

Press **Play** ▶ As Track 3 plays, watch the RSLM carefully. Watch for peak readings. The peak reading may be no more than a brief flash. Readjust the subwoofers' level control ⑧ until the peak level observed is 0dB without triggering the over-range indication. See Figure 7.

FIGURE 7

Adjusting the subwoofer levels for a 0dB peak

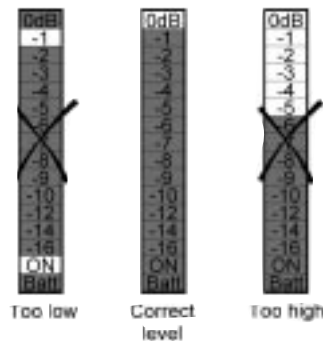

When finished, press **Pause II**.

Performing Low-Frequency Measurements

⌚ Read the following instructions fully before beginning tests.

For the following steps, you will need a Measurement Template and a pencil.

FIGURE 8

R.A.B.O.S. Measurement Template

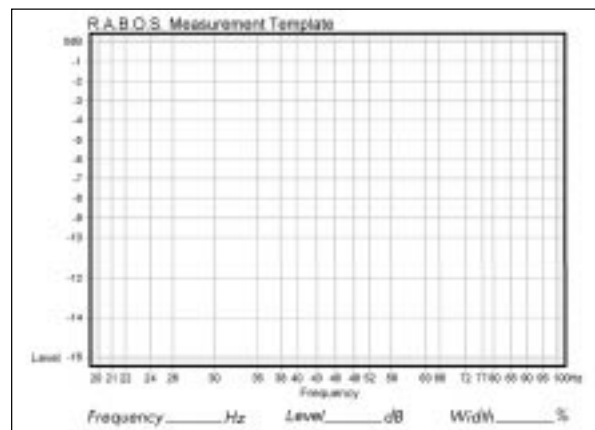

Each of the following tracks produces a low-frequency test tone. The range of these tests is from 100Hz down to 20Hz. The frequency of each test is announced before it begins. The first test is the highest frequency (100Hz); therefore, you will be marking the template from right to left. Each frequency point is listed across the bottom of the Measurement Template (this is called the X-axis). See Figure 8 on the previous page. The vertical scale on the left side of the template indicates relative level, in dBs (the Y-axis). The template's vertical scale matches that of the RSLM bar graph.

Cue Track 4 and **Pause II**.

☞ From now on, you will want to keep your CD player's remote control handy.

Press **Play** ▶. As Track 4 plays, observe the level indicated on the RSLM.

EXAMPLE: The test frequency is 100Hz and the level indicated is -2dB. Find the intersection of 100Hz (X-axis) and -2dB (Y-axis). Place a dot at that point. See Figure 9.

FIGURE 9

Locating a test point

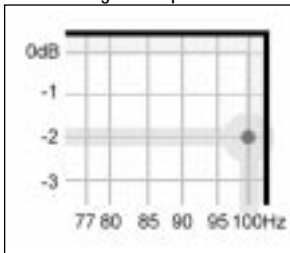

☞ It takes a few seconds for the RSLM reading to stabilize, especially at very low frequencies. Don't rush. Give each test adequate time for the meter to stabilize.

At the bottom of the bar graph is a green "ON" LED. This LED is illuminated whenever the sound level is below the measuring range of the RSLM. If this occurs during a test, place a dot at the intersection of the test frequency and the bottom frame of the template. See Figure 10.

FIGURE 10

Indicating an under-range test

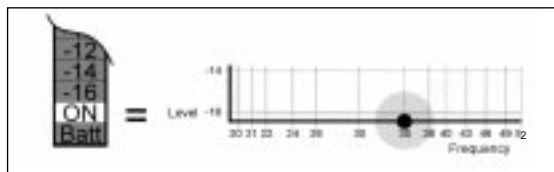

When finished, press **Skip** ▶▶ to advance to the next test. Repeat the process described above for Tracks 5 through 26.

When you have completed the 23 measurements, you are ready to analyze the data and make corrective adjustments. The completed Measurement template will look something like the example in Figure 11.

FIGURE 11

Completed R.A.B.O.S. template

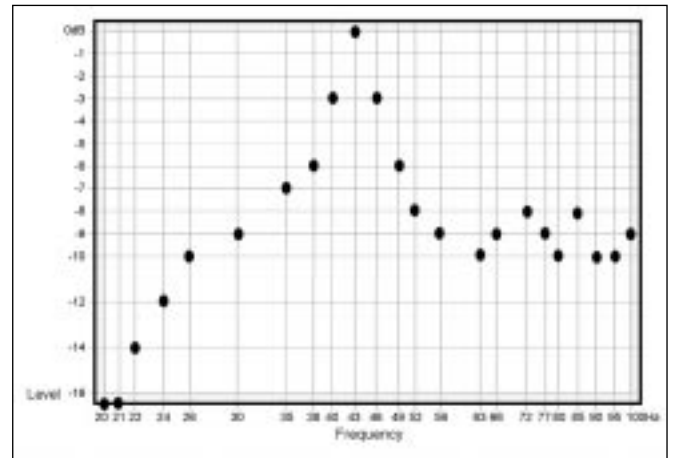

Now connect the dots as shown in Figure 12. This will make interpretation of the data much easier.

FIGURE 12

Test example with dots connected

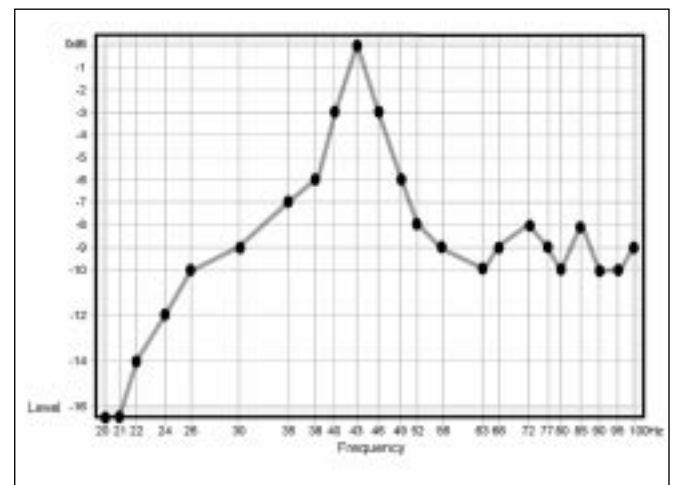

What Does a Parametric Equalizer Do?

The R.A.B.O.S. system uses one band of parametric equalization for response correction. Parametric equalizers are the most versatile class of filters. The effect an equalizer will have on the signal is dependent on three parameters.

Frequency: The equalizer will have maximum effect at one frequency, usually described as the center frequency.

Level: This refers to the amount of cut (in dBs) the equalizer is set for.

Bandwidth: Defines the range of frequencies over which the equalizer will have an effect. On the Intermezzo, this adjustment is abbreviated as "Width."

Only parametric equalizers allow independent adjustment of all three parameters.

These will be explained more fully in the sections that follow.

Completing the Measurement Template

Along the bottom of the Measurement Template are three fields where you will enter the equalizer settings needed to complete system optimization.

These instructions are based on the example in Figure 12. Use this tutorial to become familiar with the process. Strategies for several other test results will be presented later. After you have completed these three entry fields, you will be ready to perform the adjustments, completing R.A.B.O.S. optimization.

Frequency

The frequency of the R.A.B.O.S. equalizer may be adjusted to any one of nineteen frequencies from 20Hz to 80Hz. This defines where you are going to apply equalization.

Width

The frequency range of the R.A.B.O.S. equalizer may be set from 5% to 50% of an octave in 21 steps. This setting defines how much of the subwoofers' output will be equalized.

FIGURE 13

Effect of adjustable width

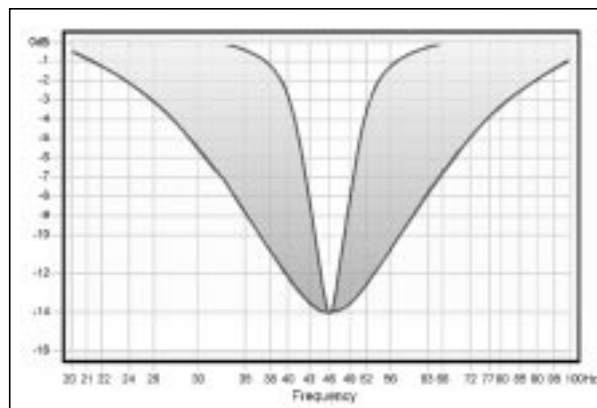

Width is expressed as a percentage of an octave. For example, a width setting of 25% means the equalizer will affect a frequency band of 1/4 of an octave; 1/8 of an octave above and 1/8 of an octave below the center frequency.

➤ The octave is a logarithmic expression. From any point in the spectrum, one octave above or below that point is always double or half the frequency. Therefore, one octave above 100Hz would be 200Hz. One octave below 100Hz is 50Hz.

In the section that follows, we will discuss the use of the Width Selector.

Using the Width Selector

① Read the following instructions carefully. The example presented may not look like the graph you just created. Focus on the concepts and techniques presented. Specific cases will be discussed later.

FIGURE 14

Width Selector

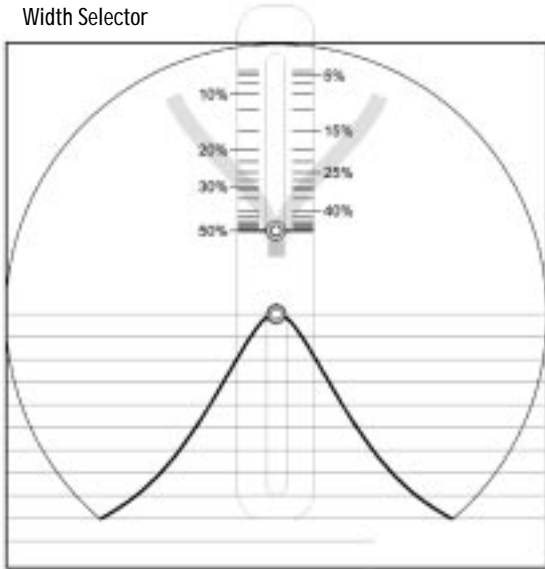

You will use the Measurement Template just completed and the Width Selector to determine the correct width setting. The Width Selector graphically depicts a single resonant peak. The peak looks similar to a slice of a pie. See Figure 14. At the top of the Selector is a pull tab. When you slide the tab up and down, the width of the pie slice becomes narrower and wider, respectively. The pointers on the sides of the button point to the bandwidth that corresponds to the width of the slice.

Place the Width Selector over the Measurement Template, positioning the center rivet of the Selector over the response peak, as shown in Figure 15. Be sure to align the horizontal lines of the Width Selector with those of the Measurement Template.

FIGURE 15

Placement of the Bandwidth Selector

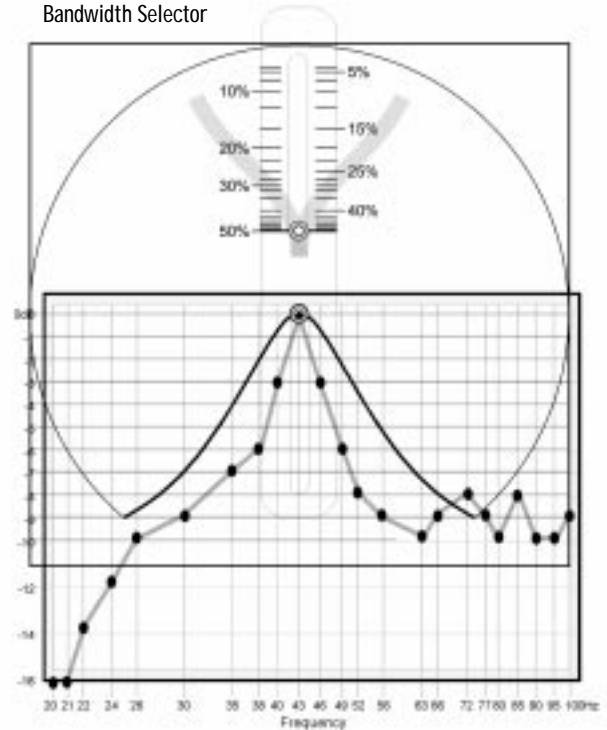

Apply pressure to the upper and lower left corners of the Selector using the thumb and forefinger of your left hand. Now gently slide the tab up or down until the adjustable slice most closely fits the response data. See Figure 16.

FIGURE 16

Selector adjusted for the "best fit"

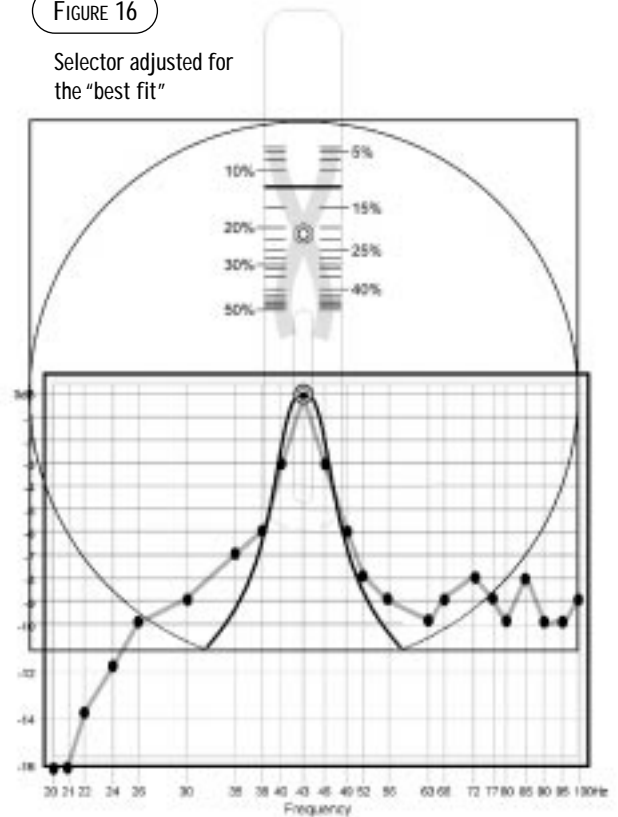

The pointer on the slider will indicate the correct width setting. Enter this number in the Width field of the Measurement Template. In our example, the width is 12.5%.

☞ It is not realistic to expect a perfect fit. Acoustic measurements encompass the behavior of not only the speakers but of the room and its contents as well. Reflected energy, standing waves and ambient noise all add their part. Determining the best width setting nearly always requires compromise.

Level

This setting will define the amount (level) you want to reduce the peak, in decibels.

The R.A.B.O.S. level adjustment is limited to attenuation only, and is adjustable from 0dB to -14dB. After optimization, the R.A.B.O.S. equalizer will eliminate the largest low-frequency peak; therefore, the broadband bass level can be increased without overpowering the midrange frequencies. R.A.B.O.S. applies this compensation automatically.

You will use the Width Selector as an aid in determining the correct level setting. Place the Width Selector as described above and adjust it to the correct width. Observe the first frequency point on the high-frequency side of the peak that no longer follows the slope of the Width Selector. In this example this is 56Hz. Calculate the average level of the readings from 56Hz up to 100Hz; that is, 10 data points in this example.

56Hz	63Hz	66Hz	72Hz	77Hz	80Hz	85Hz	90Hz	95Hz	100Hz
-9	-10	-8	-9	-10	-9	-8	-10	-10	-9

$-92 \div 10 = -9.2$

Whenever your answer has a remainder, always round down (disregarding the negative [-]) to the next whole number.

In our example, you would enter 9 in the attenuation field.

This may not be the best method in all cases. The next section contains several other examples.

What You Measure, What To Do

As stated earlier, it is not possible to anticipate the effect of every possible listening environment. However, most residential sound rooms share many characteristics, and their dimensions fall into a range that make some response irregularities far more likely than others. On the following pages are examples of what you may encounter. Following each example is a strategy for correction. Compare your measurement results with the following examples. Find the one that best fits your graph and follow the instructions presented for that scenario.

☞ Remember, when looking for a match, look at the descriptive characteristics, not any specific frequency or level. Each of these examples can occur at any frequency, bandwidth and level. It is unlikely that your test results will be exactly as depicted in these examples.

Example 1. Single Dominant Peak:

FIGURE 17

Single dominant peak

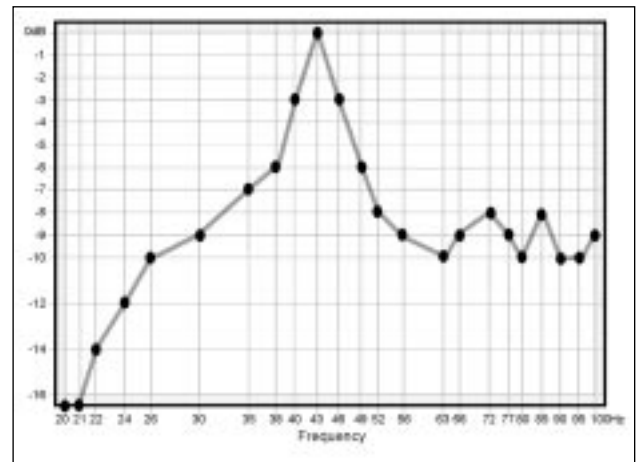

This is the most common result of speaker/room interaction.

Apply the Width Selector as described in Figure 15. Align the center-line of the Selector over the center of the peak, as shown in Figure 16. Now adjust the Selector until you have achieved the “best fit.” The slider now points to the correct bandwidth setting. In this example, the frequency is 43Hz and the best-fit width is 12.5%. Fill in the Width and Frequency fields provided on the template.

Determine the appropriate level using the technique described earlier. In this example, -9dB would be best. Enter the level in the field provided.

Skip to the “Adjusting the R.A.B.O.S. Equalizer” section on page 17.

Example 2. Two Response Peaks:

FIGURE 18

Two response peaks

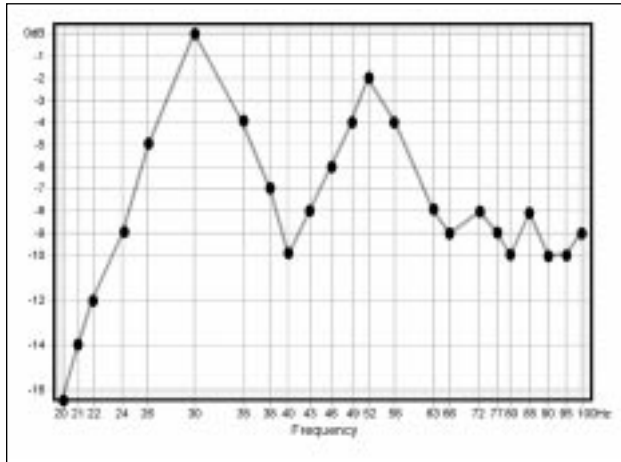

Characterized by two response peaks, approximately equal in amplitude and width. This requires that you make a choice between the two peaks. In situations like this, the higher frequency peak will always be more audible and objectionable. Response peaks below 45Hz, unless extreme, can actually be beneficial toward achieving visceral impact. Perform corrections on the upper frequency peak.

Apply the Width Selector as described above. Align the center-line of the Selector over the center of the higher frequency peak. Now adjust the Selector until you have achieved the “best fit.” The slider now points to the correct width setting. In this example, this is at 52Hz. The best-fit width is 28%. Fill in the Width and Frequency fields provided on the template.

Determine the appropriate level using the technique described earlier. This calculation will indicate a -8dB setting. However, this peak does not reach the 0dB level as the lower peak does. Therefore, a -8dB setting would be excessive. The 52Hz peak stops at -2dB. Subtracting 2 from 8 yields the correct setting, -6dB. Enter -6 in the Level field.

Skip to the “Adjusting the R.A.B.O.S. Equalizer” section on page 17.

Example 3. Peak Adjacent to a Dip:

FIGURE 19

Dip above or below peak

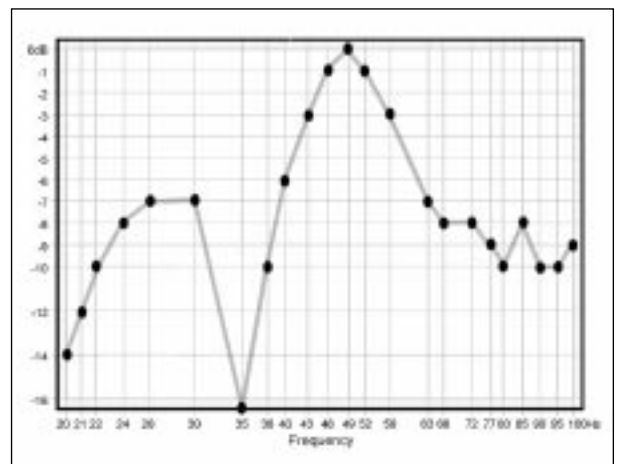
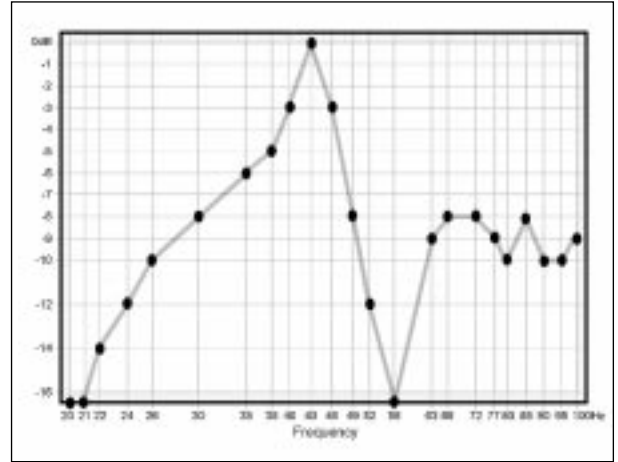

Response dips can occur at any frequency, sometimes immediately adjacent to the peak you want to correct. Two examples are shown, one immediately above and one immediately below the peak. Deep response dips such as these are caused by destructive wave interference. Destructive interference dips occur only in one spot within the room. It is not uncommon to completely eliminate the effect by moving the RSLM to a different location. Note that this does not eliminate the dips. We have simply moved away from them. Sometimes only a few inches are required. Do not attempt to correct this condition with equalization. If you encounter dips like this, take the following steps:

1. Select a new test position: Cue the test track corresponding to the center frequency of the dip. In the first example in Figure 19, you would play Track 13 (56Hz). Press **Play** ►. You will see a reading very close to what you had before. Now, slowly move the RSLM around the area, if possible remaining within about a foot of the original test point. As you move the RSLM, watch the bar graph. You will observe large level fluctuations. Find a position that restores the level to approximately that of the adjacent test points. You may find it helpful to move the RSLM vertically. Dips can be oriented in any axis. The position that restores the level to about that of the adjacent test points is your new test position.

2. Reset the test level: Return to the section "Setting the Subwoofer Test Level" on page 10. Perform the procedure as described.

3. Repeat the measurements: Now that you are familiar with the measurement process, you can go much faster by using Tracks 27–50. These tracks contain all the test tones necessary for measurement. However, each test is only about three seconds, and there is no frequency announcement. The first test is 100Hz. Just place each test mark in order until finished. Connect the dots.

Your second measurement will no longer exhibit the deep response dip. However, the peak will still be evident. Without the influence of the response dip, the amplitude and center of the peak may have changed. Compare your new data to the examples given in this section of the manual. Follow the instructions for the example that most closely matches your new measurement.

Example 4. Narrow Response:

FIGURE 20

Narrow Response

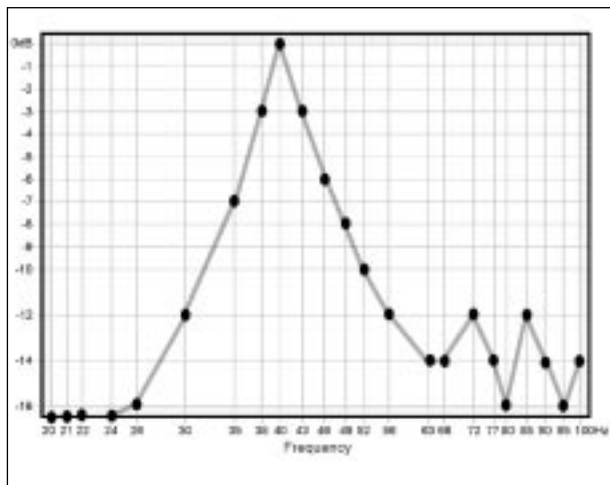

Although it looks as though this speaker is quite bass-deficient, this is actually indicative of a single, very narrow peak in excess of 10dB high.

Apply the Width Selector as described above. Align the center-line of the Selector over the center of the peak, as shown in Figure 15. Now adjust the Selector until you have achieved the "best fit". The slider now points to the correct width setting. In this example, the frequency is 40Hz and the best-fit width is 10%. Fill in the Width and Frequency fields provided on the template.

Determine the appropriate level using the technique described earlier. In this example, -13dB is indicated. Enter 13 in the field provided.

Skip to the "Adjusting the R.A.B.O.S. Equalizer" section on page 17.

Example 5. One or More Narrow Dips:

FIGURE 21

Example of two narrow dips

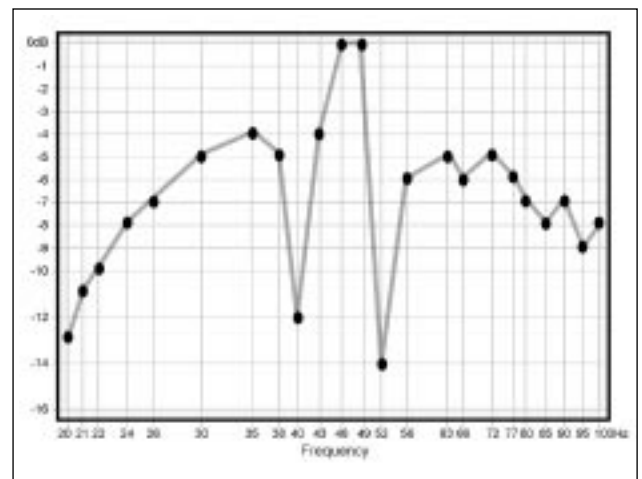

Response dips can occur at any frequency, sometimes immediately adjacent to the peak you want to correct. In this example, there are two such dips on either side of the peak. Deep response dips such as these are caused by destructive wave interference. Destructive interference dips occur only in one spot within the room. It is not uncommon to completely eliminate their effect by moving the RSLM to a different location. Note that this does not eliminate the dips. We have simply moved away from them. Sometimes only a few inches are required. Do not attempt to correct this condition with equalization. If you encounter dips like this, take the following steps:

1. Select a new test position: Cue the test track corresponding to the center frequency of the dip. In the example in Figure 21 you would play Tracks 14 (52Hz) and 18 (40Hz). Press **Play** ▶. You will see a reading very close to what you had before. Now, slowly move the RSLM around the area, if possible remaining within about a foot of the original test point. As you move the RSLM, watch the bar graph. You will observe large level fluctuations. Find a location for the subwoofer or a test location that raises the response at these frequencies. You may find it helpful to move the RSLM vertically. Dips can be oriented in any axis. The position that restores the level to about that of the adjacent test points is your new test position.

2. Reset the test level: Return to the section "Setting the Subwoofer Test Level" on page 10. Perform the procedure as described.

3. Repeat the measurements: Now that you are familiar with the measurement process, you can go much faster by using Tracks 27–50. These tracks contain all the test tones necessary for measurement. However, each test is only about three seconds, and there is no frequency announcement. The first test is 100Hz. Just place each test mark in order until finished. Connect the dots.

Your second measurement will no longer exhibit the deep response dips. However, the peak will still be evident. Without the influence of the response dips, the amplitude and center of the peak may have changed.

4. Interpret the new data: Compare your new data to the examples given in this section of the manual. Follow the instructions for the example that most closely matches your new measurement.

Example 6. Ideal Response:

FIGURE 22

Ideal response, no EQ needed

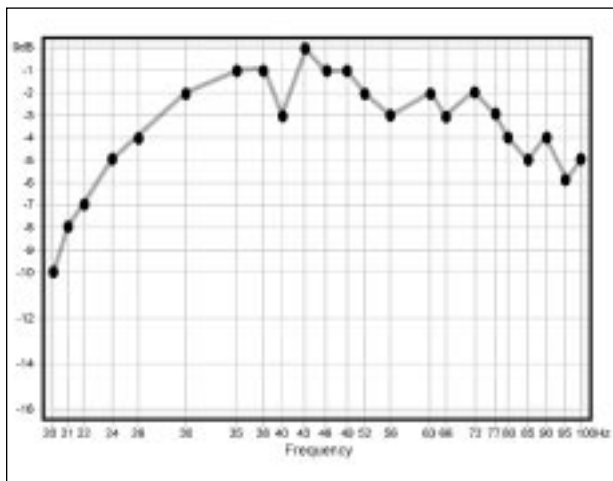

If your test data looks similar to the example in Figure 22, you have a very favorable setup. Skip to the "Final System Balance" section, page 18.

Adjusting the R.A.B.O.S. Equalizer

Now that you have performed the measurements and interpreted the data, you have the information needed to adjust the subwoofer equalizers.

There are three equalizer adjustments on each Intermezzo 4.1t. Top to bottom, they are marked "F" (frequency), "L" (level) and "W" (width). Each control has 21 positions. These are numbered from left to right. Therefore, Position 1 is the full counterclockwise position. The following table illustrates all switch positions.

Position	F (Hz)	L (dB)	W
1 CCW	20	-14.1	4.5%
2	20	-13.9	5%
3	20	-13.5	7.5%
4	21	-13.1	10%
5	22	-12.7	12.5%
6	24	-11.7	16.5%
7	26	-11.0	20.5%
8	30	-10.2	23%
9	35	-9.5	26%
10	38	-8.9	28%
11	40	-8.3	29.5%
12	43	-7.9	31%
13	46	-6.4	34%
14	49	-4.4	39%
15	52	-2.9	41.5%
16	56	-1.9	43.5%
17	63	-1.1	45%
18	66	-0.5	46.5%
19	72	0.0	48%
20	77	0.0	49%
21 CW	80	0.0	49.5%

You must use the R.A.B.O.S. key to adjust these controls. Always adjust both subwoofers together. Using the adjustment key, adjust the controls as indicated by the Measurement Template. Each value shown in the table is represented by detents in the R.A.B.O.S. controls. Simply count the number of detents necessary, indicated by the results of your R.A.B.O.S. Test.

Intermezzo 4.1t R.A.B.O.S. Controls

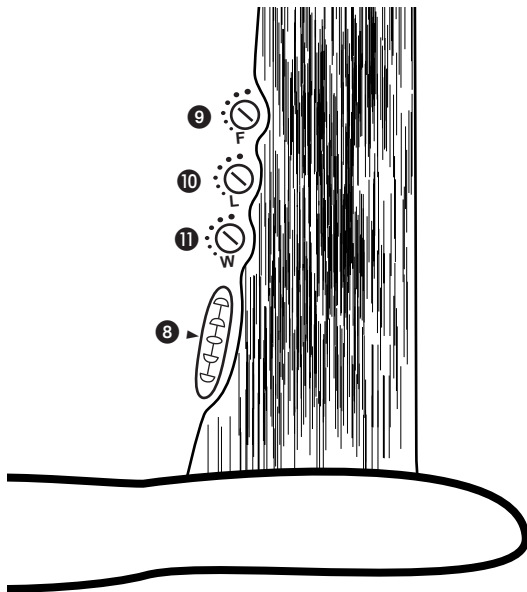

After performing these adjustments, you may skip forward to the “Final System Balance” section. It is recommended that you perform a second measurement to confirm that the settings are correct.

❗ If you are going to retest the system after EQ adjustments, repeat the “Setting the Subwoofer Test Level” section on p. 10.

🔁 Retesting the system will go much faster if you use Tracks 27–50. These tracks contain all the same test tones you just used. However, each tone plays for only a few seconds and there is no frequency announcement. If you are uncomfortable operating at this pace, you may, of course, perform measurements with the original test tracks.

Your first interpretation of the data and choice of settings may not be optimum. You can repeat the test-adjust-test cycle as often as needed to get the desired results. To do this, return to page 10, “Setting the Subwoofer Test Level.” You may prefer to retest using the same template. Doing so makes it easy to evaluate the improvement.

When you are satisfied with the results, go to “Final System Balance.”

Final System Balance

Cue Track 51 of the R.A.B.O.S. Test CD. Press **Play** ▶. Increase the system volume until the RSLM indicates -10dB. Now play Track 52. Adjust both subwoofer gain controls until -10dB is indicated on the RSLM. Of course, you may fine-tune the subwoofer gain control to your listening preference.

This concludes the R.A.B.O.S. process. It is recommended that you remove the battery from the RSLM. Store the Test CD, Width Selector, Adjustment Key and the RSLM together.

MAINTENANCE AND SERVICE

The Intermezzo 4.1t may be cleaned using a soft cloth, dampened with water only, to remove fingerprints or to wipe off dust.

The grille may be gently vacuumed. Stains may be removed with an aerosol cleaner, following its instructions. Do not use any solvents on the grille.

All wiring connections should be inspected and cleaned or remade periodically. The frequency of maintenance depends on the metals involved in the connections, atmospheric conditions, and other factors, but once per year is the minimum.

If a problem occurs, make sure that all connections are properly made and clean. If a problem exists in one loudspeaker, reverse the connection wires to the left and right system. If the problem remains in the same speaker, then the fault is with the loudspeaker. If the problem appears in the opposite speaker, the cause is in another component or cable. In the event that your Intermezzo 4.1t loudspeaker system ever needs service, contact your local Infinity dealer or Infinity directly at 1-800-553-3332 or www.infinitysystems.com.

SPECIFICATIONS

Intermezzo 4.1t System

Frequency Response: 23Hz – 22kHz (± 3 dB)
30Hz – 20kHz (± 1.5 dB)

Impedance: 6 Ω

Sensitivity: 87dB
(2.83V @ 1 meter)

**Recommended
Amplifier Power Range:** 25 – 500 watts

Subwoofer Amplifier Output: 850 watts continuous
(In to 8 Ω from 20Hz – 100Hz
with no more than 0.1% THD) 2,600 watts peak

**2nd- and 3rd-Order
Harmonic Distortion:** <1%
(20Hz – 20kHz @ 95dB SPL)

Crossover Frequencies: 80Hz, 500Hz, 2800Hz
24dB/Octave

Dimensions: 51-1/2" x 12-1/2" x 27-1/8"
(1308mm x 318mm x 689mm)

Weight: 93 lb
(42.3kg)

Infinity continually strives to update and improve existing products, as well as create new ones. The specifications and construction details in this and related Infinity publications are therefore subject to change without notice.

R.A.B.O.S. Measurement Template

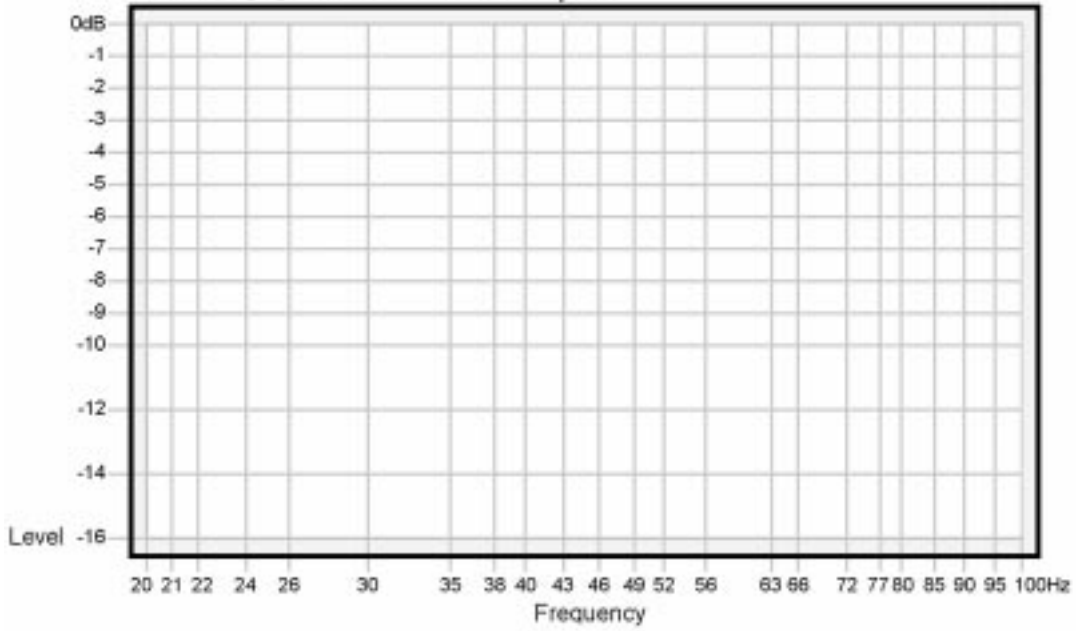

Frequency _____ Hz Level _____ dB Width _____ %

R.A.B.O.S. Measurement Template

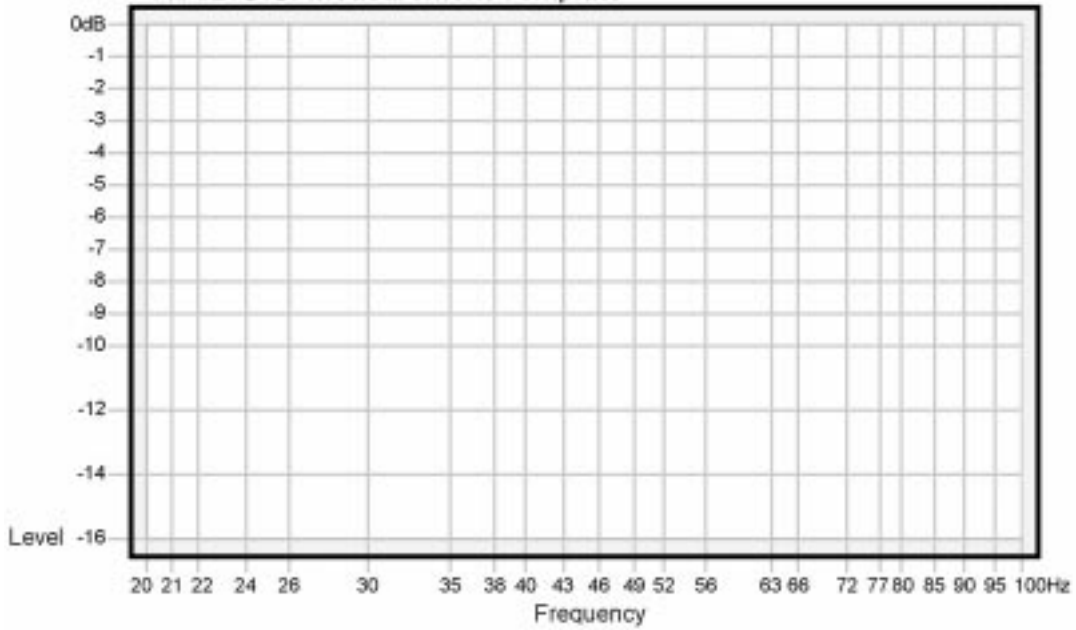

Frequency _____ Hz Level _____ dB Width _____ %

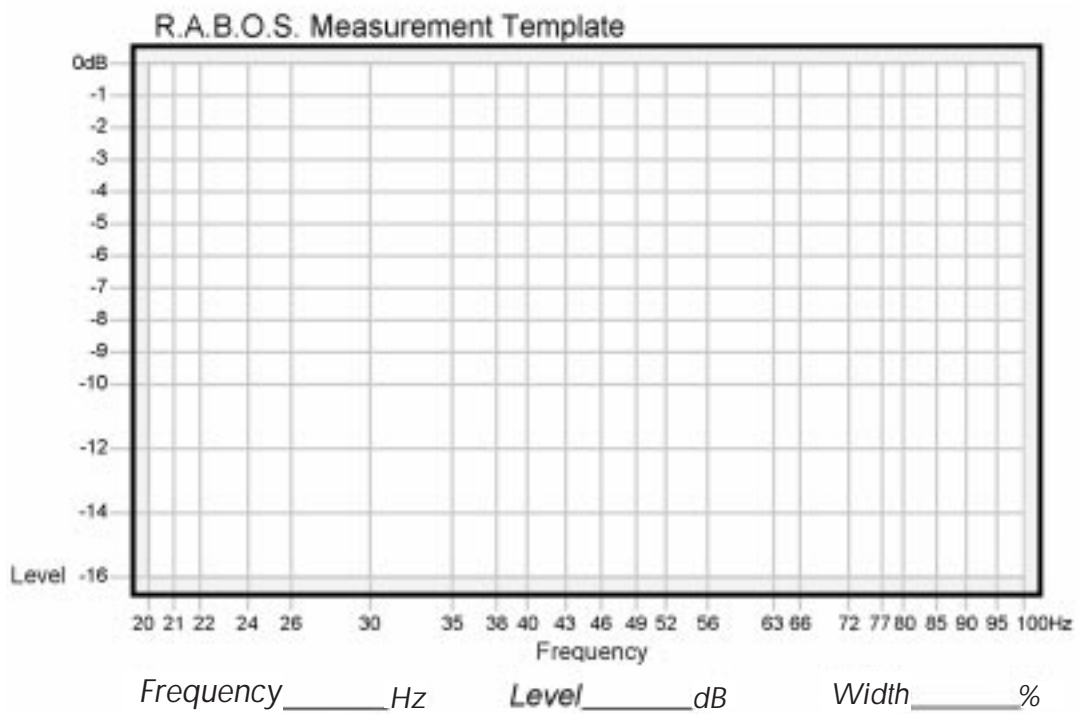
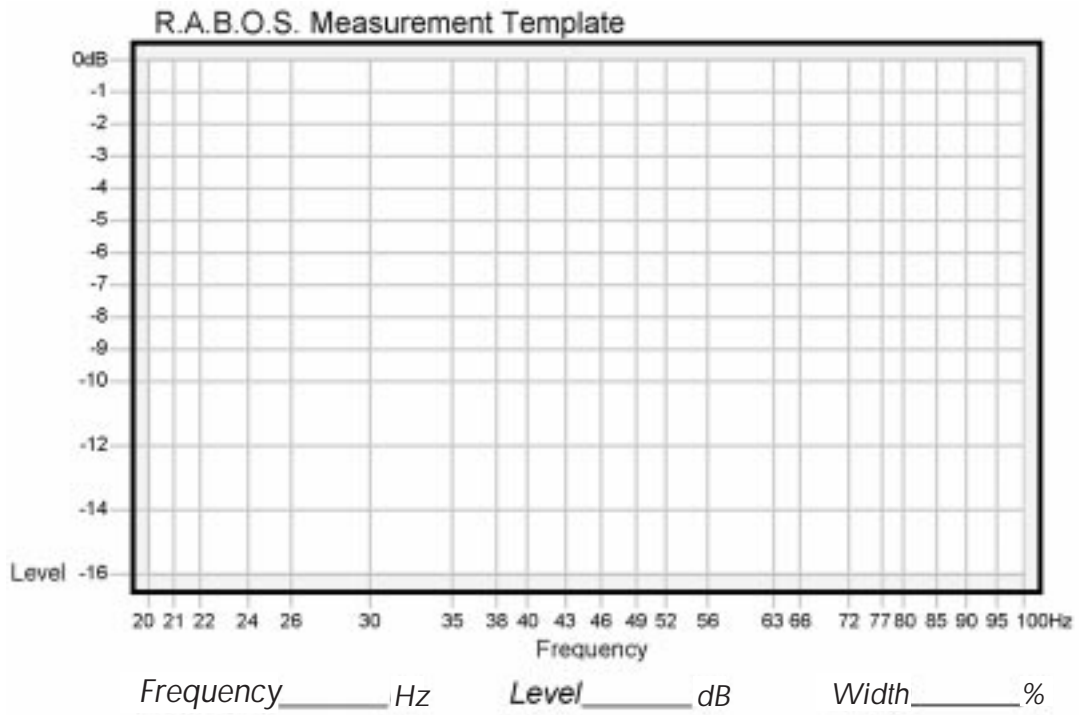

NOTES:



A Harman International Company © 2000 Infinity Systems, Inc., 250 Crossways Park Drive, Woodbury, NY 11797 USA (800) 553-3332 (USA Only) www.infinitysystems.com

*Trademarks of Dolby Laboratories. THX is a registered trademark of Lucasfilm, Ltd. DTS is a registered trademark of Digital Theater Systems, Inc. BASH is a registered trademark of Indigo Corporation. Infinity is a registered trademark of Infinity Systems, Inc. Printed in USA 3/00 Part No. 336205-001